

REV.	ECN NO.	LOCATIONS	DESCRIPTION	DATE	DESIGN
A1			REVISED SOME DETAILS	04/21'18	Hank

CUSTOMER DRAWING

RoHS Compliant

ORDERING INFORMATION

MCCF - R1K5 (XX T)

- ① **PRODUCT SERIES:**
 USB C TYPE connector -
 Receptacle (Female) side.
- ② **ITEM NO.:**
 Right Angle- Single Row SMD 16pin
 Sink1.86/ Body 6.5L

- ③ **GOLD PLATING :**
 03: 3u"
 15: 15u"
 30: 30u"

3D VIEW

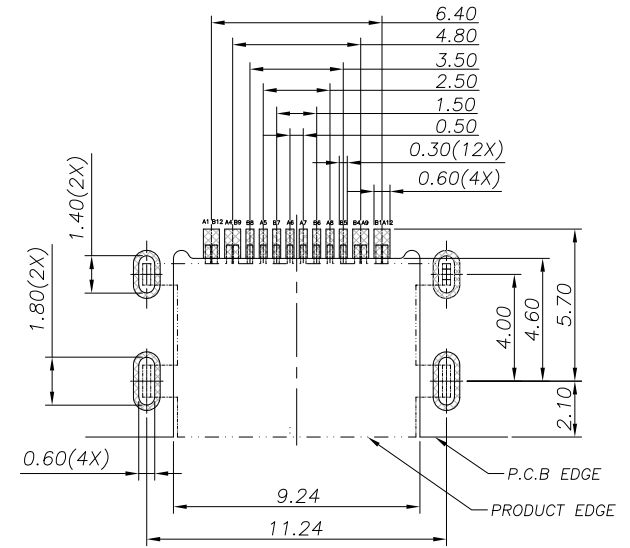
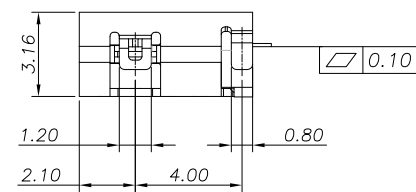
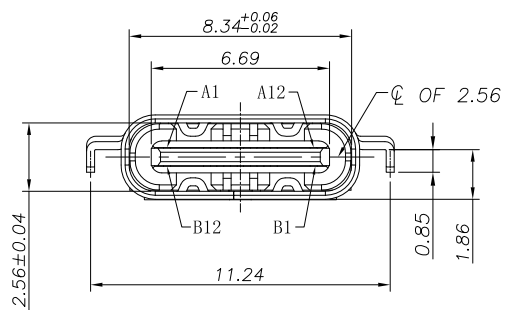
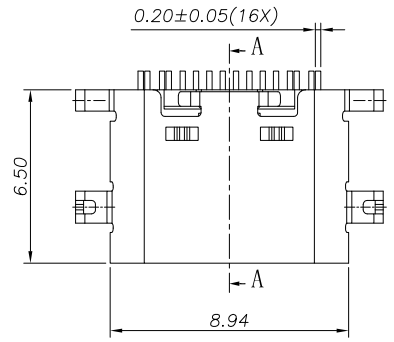
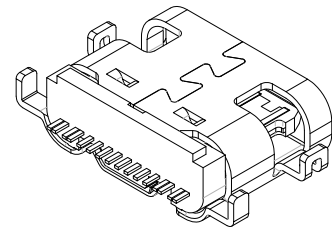

RECOMMENDED P.C.B. LAYOUT

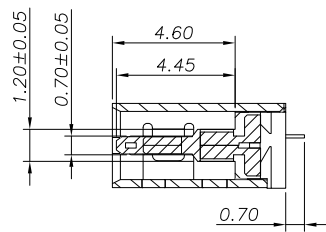

SECTION: A-A

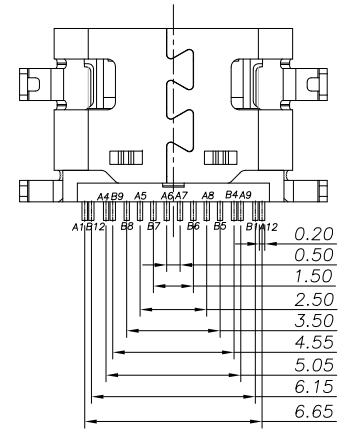

PIN ASSIGNMENTS

PIN NO.	A1	A4	A5	A6	A7	A8	A9	A12
SIGNAL NAME	GND	VBUS	CC1	Dp1	Dn1	SBU1	VBUS	GND
PIN NO.	B12	B9	B8	B7	B6	B5	B4	B1
SIGNAL NAME	GND	VBUS	SBU2	Dn2	Dp2	CC2	VBUS	GND

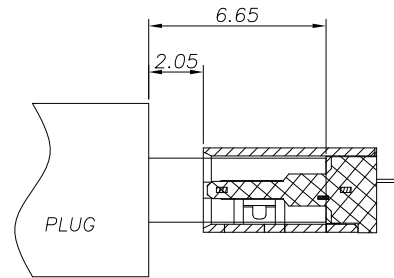

AFTER MATING

NOTES:

1. MATERIAL:
 (1) HOUSING: HIGH TEMP plastic, UL94 V-0.
 (2) CONTACT: COPPER ALLOY.
 (3) MID PLATE: STAINLESS STEEL.
 (4) SHELL: STAINLESS STEEL.
2. PLATED:
 (1) CONTACT: GOLD ON CONTACT AREA OVER NICKEL PLEATED OVERALL.
 (2) SHELL: NICKEL PLATED OVERALL.
 (3) MID PLATE: CLEAR ONLY

SUNFUN		SUNFUN TECHNOLOGY LTD			
DRAW NO.	MCCF-R1K5(A1)	DATE	04/21'18	MATERIAL:	SEE NOTES
DESIGN:	Hank	04/21'18	FINISH:	SEE NOTES	
CHECK:	Hank	04/21'18	FILE:	MCCF-R1K5(A1)	
REVIEW:	Rui	04/21'18	P/N:	MCCF-R1K5(XXT)	
APPROVED	Rui	04/21'18	REV. A1	SCALE	
DRAW NAME:		USB C Type CONN - FEMALE			
DESIGN:		Right Angle- Single Row SMD 16pin			
CHECK:		Sink1.86 /Body 6.5L			
REVIEW:		MODEL: USB C TYPE CONN			
APPROVED:		UNIT:	SHEET:		
		mm	1/1		

DIM	TOL
X.X	±0.30
X.XX	±0.20
X.XXX	±0.10