

REV.	ECN NO.	LOCATIONS	DESCRIPTION	DATE	DESIGN
A1			REVISED SOME DETAILS	08/31'17	Hank

ORDERING INFORMATION

MCCF - R1K6 (XX T)

① ② ③

① PRODUCT SERIES:

USB C TYPE connector -
Receptacle (Female) side.

② ITEM NO.:

Right Angle- Single Row SMD 16pin
Sink2.10/ Body 6.5L

CUSTOMER DRAWING

RoHS Compliant

③ GOLD PLATING :

03: 3u".
15: 15u".
30: 30u".

3D VIEW

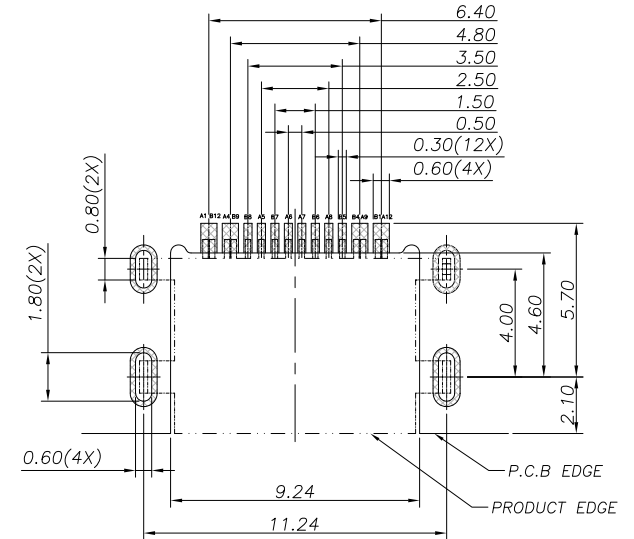
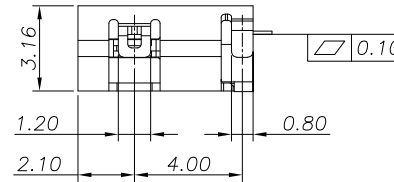
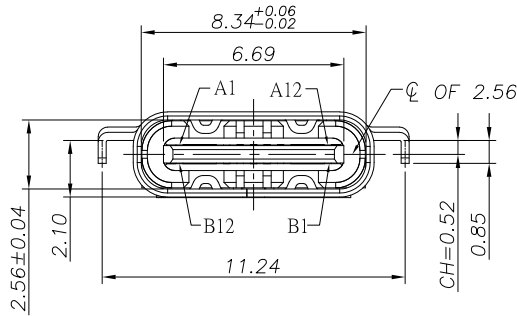
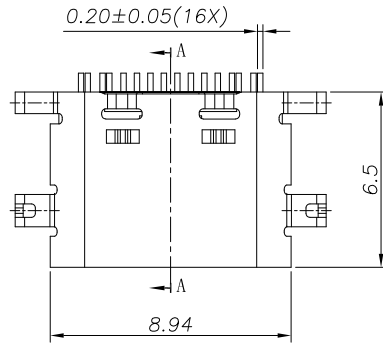
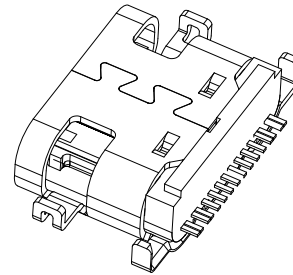

RECOMMENDED P.C.B. LAYOUT

NOTES:

1. MATERIAL:

- (1) HOUSING: HIGH TEMP plastic, UL94 V-0.
- (2) CONTACT: COPPER ALLOY.
- (3) MID PLATE: STAINLESS STEEL.
- (4) SHELL: STAINLESS STEEL.

2. PLATED:

- (1) CONTACT: GOLD ON CONTACT AREA OVER NICKEL PLEATED OVERALL.
- (2) SHELL: NICKEL PLATED OVERALL.
- (3) MID PLATE: CLEAR ONLY

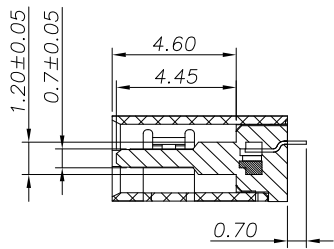

SECTION:A-A

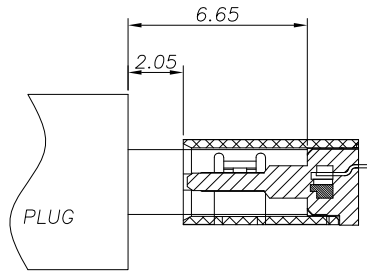
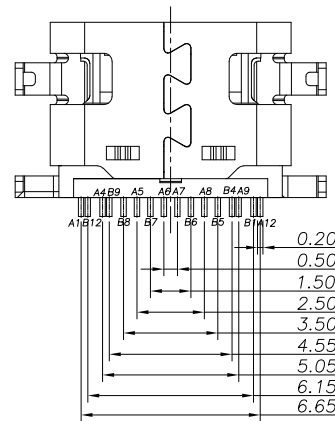

AFTER MATING

PIN ASSIGNMENTS

PIN NO.	A1	A4	A5	A6	A7	A8	A9	A12
SIGNAL NAME	GND	VBUS	CC1	Dp1	Dn1	SBU1	VBUS	GND
PIN NO.	B12	B9	B8	B7	B6	B5	B4	B1
SIGNAL NAME	GND	VBUS	SBU2	Dn2	Dp2	CC2	VBUS	GND

DIM	TOL
X.X	±0.30
X.XX	±0.20
X.XXX	±0.10

SUNFUN		SUNFUN TECHNOLOGY LTD			
DRAW NO.	MCCF-R1K6(A1)	DATE	08/31'17	MATERIAL:	SEE NOTES
DESIGN:	Hank	08/31'17	FINISH:	SEE NOTES	DRAW NAME:
CHECK:	Hank	08/31'17	FILE:	MCCF-R1K6(A1)	USB C Type CONN - FEMALE
REVIEW:	Rui	08/31'17	P/N:	MCCF-R1K6(XXT)	Right Angle- Single Row SMD 16pin
APPROVED	Rui	08/31'17	REV. A1	SCALE	MODEL: USB C TYPE CONN
				UNIT:	mm
				SHEET:	1/1