

REV.	ECN NO.	LOCATIONS	DESCRIPTION	DATE	DESIGN
A2			REVISED SOME DETAILS	12/24'18	Hank

CUSTOMER DRAWING

RoHS Compliant

ORDERING INFORMATION

MCCF - R2K1 (XX T)

1 PRODUCT SERIES:

USB C TYPE connector -
Receptacle (Female) side.

2 ITEM NO.:

Right Angle- Dual Row 24 pin
Sink 0.8/Body 7.9L

3 GOLD PLATING :

03: 3u".
15: 15u".
30: 30u".

3D VIEW

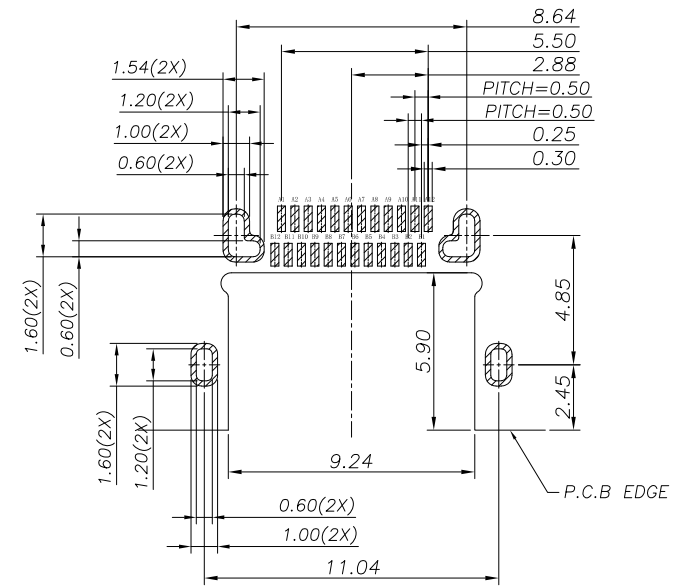
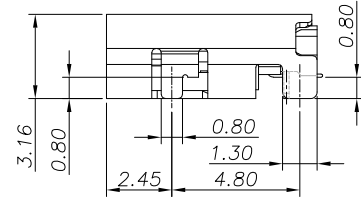
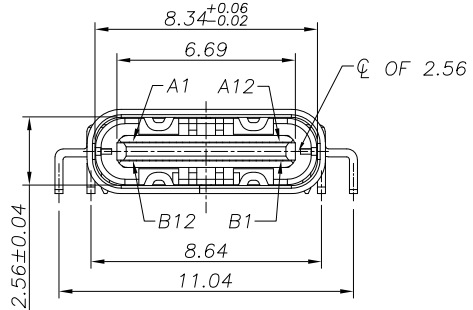
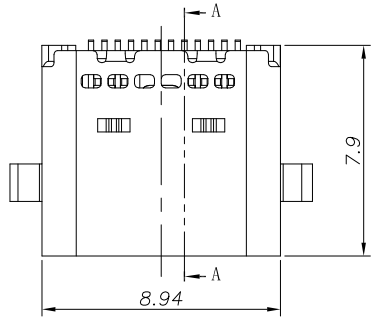
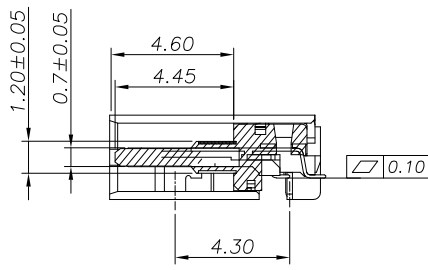
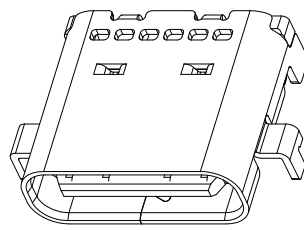

RECOMMENDED P.C.B. LAYOUT
THICKNESS 0.60±0.05MM

NOTES:

- MATERIAL:
 - HOUSING: HIGH TEMP plastic, UL94 V-0.
 - CONTACT: COPPER ALLOY.
 - MID PLATE: STAINLESS STEEL.
 - SHELL: STAINLESS STEEL.
- PLATED:
 - CONTACT: GOLD ON CONTACT AREA OVER NICKEL PLEATED OVERALL.
 - SHELL: NICKEL PLEATED OVERALL.
 - MID PLATE: CLEAR ONLY

USB TYPE-C PIN ASSIGNMENTS

PIN NO.	SIGNAL NAME
A1	GND
A2	SSTXp1
A3	SSTXn1
A4	Vbus
A5	CC1
A6	Dp1
A7	Dn1
A8	SBU1
A9	VBUS
A10	SSRXn2
A11	SSRXp2
A12	GND

PIN NO.	SIGNAL NAME
B12	GND
B11	SSRXp1
B10	SSRXn1
B9	Vbus
B8	SBU2
B7	Dn2
B6	Dp2
B5	CC2
B4	Vbus
B3	SSTXn2
B2	SSTXp2
B1	GND

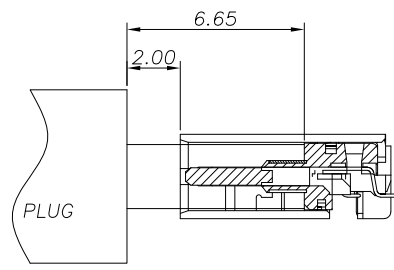
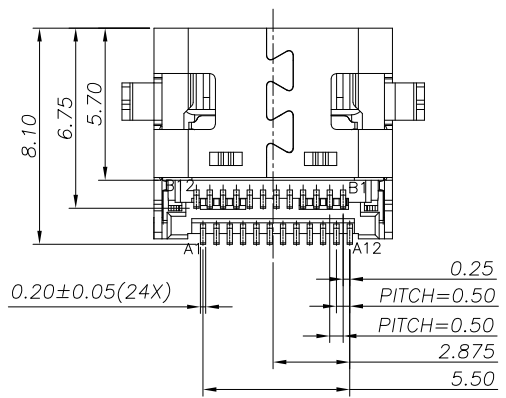

AFTER MATING

DIM	TOL
X.X	±0.30
X.XX	±0.20
X.XXX	±0.10

SUNFUN		SUNFUN TECHNOLOGY LTD			
DRAW NO.	MCCF-R2K1(A2)	DATE	12/24'18	MATERIAL:	SEE NOTES
DESIGN:	Hank	12/24'18	FINISH:	SEE NOTES	DRAW NAME:
CHECK:	Hank	12/24'18	FILE:	MCCF-R2K1(A2)	USB C Type CONN - FEMALE
REVIEW:	Rui	12/24'18	P/N:	MCCF-R2K1(XXT)	Right Angle- Dual Row 24 pin
APPROVED	Rui	12/24'18	REV. A2	SCALE	Sink 0.8/Body 7.9L
			MODEL:	USB C TYPE CONN	
			UNIT:	mm	SHEET:
					1/1