

REV.	ECN NO.	LOCATIONS	DESCRIPTION	DATE	DESIGN
A2			UPDATE SOME DETAILS	03/05'19	John

ORDERING INFORMATION

SMHN - S01 (XX T)

- ① **PRODUCT SERIES:**
Nano-SIM CARD SOCKET-HINGE TYPE.
- ② **ITEM NO.:**
6PIN/ 1.45H.

CUSTOMER DRAWING

RoHS Compliant

③ **GOLD PLATING**

- 01: G/F,
- 05: 5u",
- 10: 10u",
- 15: 15u",
- 30: 30u".

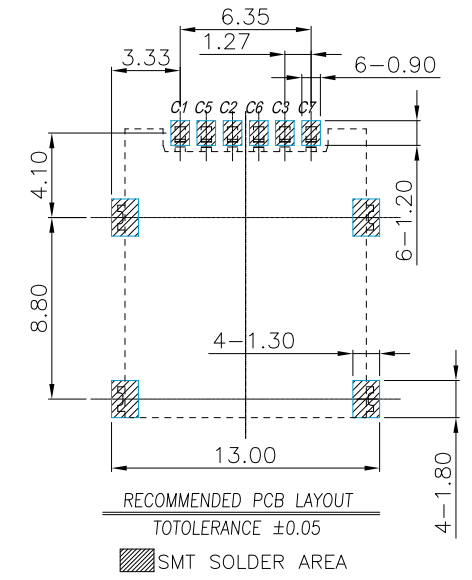
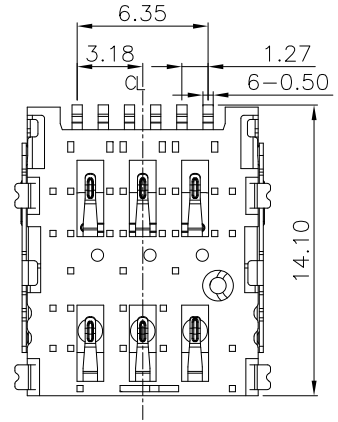
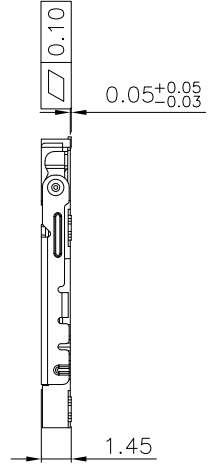
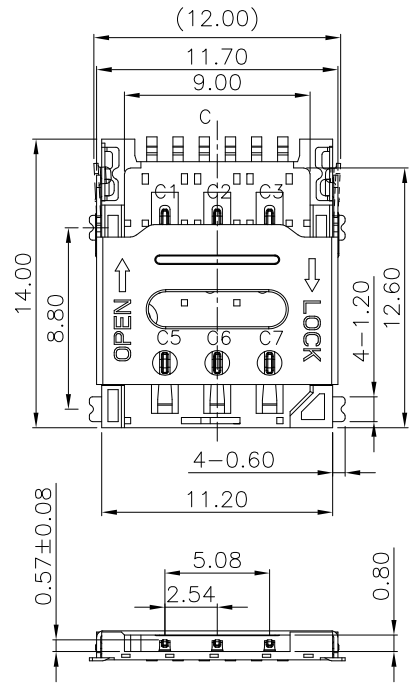

NOTES:

- 1. MATERIAL:
 - 1-1. HOUSING: LCP, UL 94V-0, BLACK COLOR.
 - 1-2. TERMINAL: COPPER ALLOY.
 - 1-3. SHELL: STAINLESS STEEL.
- 2. FINISH:
 - 2-1. TERMINAL: GOLD ON CONTACT AREA, OVER NICKEL UNDER-PLATED OVERALL.

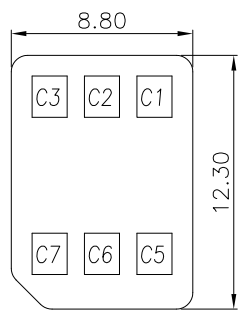
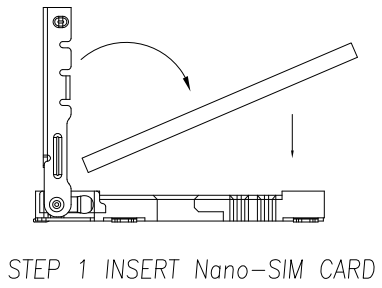

SIM CARD	
Pin No.	NAME
C1	VCC
C2	RST
C3	CLK
C5	GND
C6	VPP
C7	I/O

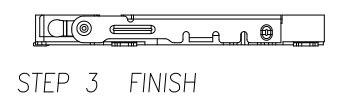
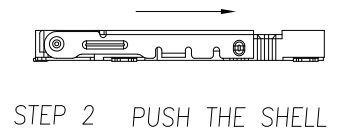

DIM	TOL
X.X	±0.30
X.XX	±0.20
X.XXX	±0.10

SUNFUN		SUNFUN TECHNOLOGY LTD			
DRAW NO.	SMHN-S01(A2)	DATE	MATERIAL: SEE NOTES	DRAW NAME:	
DESIGN:	John	03/05'19	FINISH: SEE NOTES	Nano-SIM CARD SOCKET	
CHECK:	John	03/05'19	FILE: SMHN-S01(A2)	HINGE TYPE/ 6PIN	
REVIEW:	Frank	03/05'19	P/N: SMHN-S01(XXT)	1.45H	
APPROVED	Frank	03/05'19	REV. A2	MODEL:	NANO-SIM CARD CONN
			SCALE	UNIT:	mm
				SHEET:	1/1